



**POWER SOLUTIONS  
INTERNATIONAL**

# **OPERATION & MAINTENANCE MANUAL**

---

**CERTIFIED STATIONARY  
PRODUCT LINE**

# Table of Contents

## Contents

Introduction.....	3
How to Use this Manual .....	3
Engine Identification.....	3
Parts and Service.....	4
Service Literature.....	4
Certified Engine Emissions Information .....	5
Example MOR Label.....	6
Operating Instructions .....	9
Starting the Engine .....	10
Stopping the Engine.....	10
Fuel Recommendations .....	11
MAINTENANCE INSTRUCTIONS.....	13
Cooling System.....	16
Fuel Filter.....	17
Ignition Systems .....	18
Storage .....	19
Engine Maintenance Requirements .....	20
GENERAL SPECIFICATIONS.....	21

No part of this publication may be reproduced without written permission from Power Solutions, Inc. At the time of publication, all of the information included in this publication is accurate to the best of our knowledge. Power Solutions, Inc. cannot be responsible for information that has changed after this book was published.

# Introduction

Power Solutions, Inc. is pleased that you have selected our engine for your requirements. Power Solutions, Inc. takes great pride in our tradition of quality products produced from our line of industrial gasoline and alternative fuel engines.

Prior to starting the engine at your facility, certain checks should be made. Please read the Initial Start-Up inspection requirements in the Maintenance Section of this manual. If you have further questions please contact your PSI account representative or Customer Support Engineer

## How to Use this Manual

This manual contains instructions on the safe operation and preventive maintenance of your PSI industrial engine. We urge you to read this manual prior to start up or operation of the engine.

The Table of Contents permits you to quickly open the manual to any section.

Power Solutions, Inc., engines are built with a variety of standard and/or optional components to suit a broad range of customer requirements. This manual does not identify equipment as standard or optional. All the equipment described in this manual may not be found on your engine or power unit.

Please pay special attention to the NOTES, CAUTIONS, and WARNINGS. WARNINGS remind you to be careful in areas where carelessness can cause personal injury. CAUTIONS are given to prevent you from error that could cause damage to the equipment. NOTES give you added information designed to help you.

The descriptions and specifications contained in this manual were in effect at the time of publication. Power Solutions, Inc. reserves the right to discontinue models at any time, or to change specifications or design without notice and without incurring obligation.

## Engine Identification

Your PSI engine will have an engine serial number identification label located at the top or near the top/side of the engine. The engine serial number is also stamped into the left side of the cylinder block near the engine flywheel. Depending on the vintage and certification level the label could be in one of two formats. The two labels shown here contain the engine serial number highlighted in yellow.

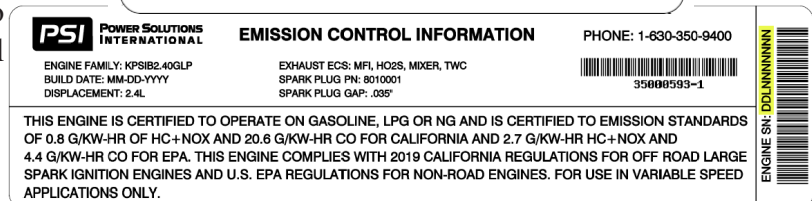
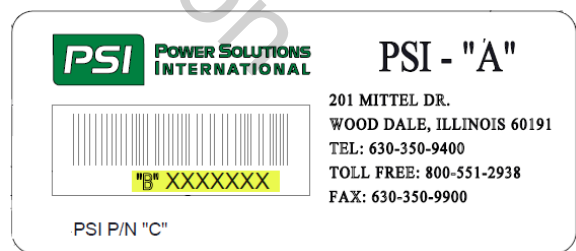

## Parts and Service

Replacement parts can be obtained from Power Solutions, Inc. by calling the Aftermarket Parts Department at 888-331-5769. The engine model and serial number will be required when seeking information and/or ordering parts.

Service and technical support for PSI engines can be obtained by contacting the Service Department at 888-331-5764 or via email at [service@psiengines.com](mailto:service@psiengines.com).

## Service Literature



Additional operator manuals and service manuals for specific PSI engines can be obtained by contacting the Parts or Service Department at 888-331-5769 or [parts@psiengines.com](mailto:parts@psiengines.com)

Not for reproduction

## Certified Engine Emissions Information

The engine installed in your equipment is certified by POWER SOLUTIONS INTERNATIONAL, INC. with the U.S. Environmental Protection Agency and the California Air Resources Board. The engine assembly is certified by PSI and is installed into your equipment by the equipment manufacturer following PSI's installation guidelines. Depending on the vintage of your engine, the emissions control information label could be in one of two formats. Both labels will identify the engine emissions family standards and additional required information. Newer labels will contain the engine serial number on the right hand portion of the label as shown below.

### Example Label:

 <b>POWER SOLUTIONS INTERNATIONAL</b> ENGINE FAMILY: KPSIB2.40GLP BUILD DATE: MM-DD-YYYY DISPLACEMENT: 2.4L	<b>EMISSION CONTROL INFORMATION</b> EXHAUST ECS: MFI, HO2S, MIXER, TWC SPARK PLUG PN: 8010001 SPARK PLUG GAP: .035"	PHONE: 1-630-350-9400  35000593-1	 ENGINE SN: DLLNNNNNN
		THIS ENGINE IS CERTIFIED TO OPERATE ON GASOLINE, LPG OR NG AND IS CERTIFIED TO EMISSION STANDARDS OF 0.8 G/KW-HR OF HC+NOX AND 20.6 G/KW-HR CO FOR CALIFORNIA AND 2.7 G/KW-HR HC+NOX AND 4.4 G/KW-HR CO FOR EPA. THIS ENGINE COMPLIES WITH 2019 CALIFORNIA REGULATIONS FOR OFF ROAD LARGE SPARK IGNITION ENGINES AND U.S. EPA REGULATIONS FOR NON-ROAD ENGINES. FOR USE IN VARIABLE SPEED APPLICATIONS ONLY.	

 <b>POWER SOLUTIONS INTERNATIONAL</b>	<b>EMISSION CONTROL INFORMATION</b>		EXHAUST ECS : MFI, HO2S, MIXER, TWC SPARK PLUG : R42LTS OR R44LTS SPARK PLUG GAP : .035"
	ENGINE FAMILY: EPSIB4.30GLP DISPLACEMENT: 4.3L	THIS ENGINE IS CERTIFIED TO OPERATE ON GASOLINE, LPG OR NG AND IS CERTIFIED TO EMISSION STANDARDS OF 0.8 G/KW-HR OF HC+NOX AND 20.6 G/KW-HR OF CO FOR CALIFORNIA AND 2.7 G/KW-HR OF HC+NOX AND 4.4 G/KW-HR OF CO FOR EPA. THIS ENGINE COMPLIES WITH 2014 CALIFORNIA REGULATIONS FOR OFF-ROAD LARGE SPARK-IGNITION ENGINES AND U.S. EPA REGULATIONS FOR NONROAD AND STATIONARY ENGINES. FOR GASOLINE USE IN VARIABLE SPEED APPLICATIONS ONLY.	
			LABEL PN: 36000330-01

The engine's emission control system does not require any adjustments, but the engine does require Preventative Maintenance (PM). Your obligation as the owner of the engine/equipment is to follow the engine's PM requirements outlined in this manual and to keep the engine in the proper working order. The equipment your engine is installed in will have a malfunction indicator lamp (MIL) for diagnosis of the engine's emission control system. If this lamp is illuminated it is important to have the engine repaired. Failure to keep the engine in the proper state of repair can affect the performance of the engine's emission control system. Any unapproved modification to the engine's emission control system may potentially violate the engine's emission certification and may be subject to civil penalty.

The equipment manufacturer and/or equipment dealer will be your best resource regarding the proper support and information pertaining to the PSI certified engine and the equipment. Please contact the equipment manufacturer or equipment dealer first for questions and further information. You may contact PSI directly if you are unable to reach the equipment manufacturer or dealer. The PSI Service Department can be contacted at 888-331-5764.

Your PSI certified engine is covered by an Emission Control System Warranty (Warranty Statement contained in this section). Your equipment and engine is warranted to you by the equipment manufacturer. In the event you are unable to receive warranty from the equipment manufacturer or equipment dealer you can contact PSI directly for assistance with your PSI certified engine emission control system warranty. The PSI Warranty Department can be contacted at 888-331-5764.

## Example MOR Label

### CALIFORNIA AND US EPA EMISSION CONTROL WARRANTY STATEMENT YOUR WARRANTY RIGHTS AND OBLIGATIONS

The **California Air Resources Board, United States Environmental Protection Agency, and Power Solutions International, Inc. (PSI)** are pleased to explain the **emission control system warranty** on your 2014 or later model year large spark-ignition (LSI) engine. In California, new LSI engines must be designed, built and equipped to meet the State's stringent anti-smog standards. Power Solutions International, Inc. must warrant the emission control system on your LSI engine for the periods of time listed below provided there has been no abuse, neglect or improper maintenance of your LSI engine.

Your emission control system may include parts such as the carburetor, regulator or fuel-injection system, ignition system, engine computer unit (ECM), catalytic converter and air induction system. Also, included may be sensors, hoses, belts, connectors and other emission-related assemblies.

Where a warrantable condition exists, Power Solutions International, Inc. will repair your LSI engine at no cost to you including diagnosis, parts and labor.

#### MANUFACTURER'S WARRANTY COVERAGE

The 2014 or later model year large spark-ignition engines are warranted for **2500 hours** or **three years**, whichever occurs first (**3500 hours** or **five years** for high cost warranty parts). If any emission-related part on your engine is defective, the part will be repaired or replaced by Power Solutions International, Inc.

#### OWNER'S WARRANTY RESPONSIBILITIES

As the equipment and LSI engine owner, you are responsible for the performance of the **required maintenance listed in your owner's manual**. Power Solutions International, Inc. recommends that you retain all receipts covering maintenance on equipment and LSI engine, but Power Solutions International, Inc. cannot deny warranty solely for the lack of receipts or for your failure to ensure the performance of all scheduled maintenance.

As the equipment or LSI engine owner, you should however be aware that Power Solutions International, Inc. may deny you warranty coverage if equipment or LSI engine or a part has failed due to abuse, neglect, improper maintenance or unapproved modifications.

Your engine is designed to operate on gasoline, LPG and/or CNG. Use of any other fuel may result in your engine no longer operating in compliance with California's and the US EPA's emissions requirements.

You are responsible for presenting your equipment or LSI engine to a Power Solutions International, Inc. distribution center as soon as a problem exists. The warranty repairs should be completed by the dealer as expeditiously as possible.

If you have any questions regarding your warranty rights and responsibilities, you should contact Power Solutions International, Inc. via telephone at **1-800-551-2938** or contact Power Solutions International, Inc. in writing at:

**Power Solutions International, Inc.**  
**201 Mittel Dr.**  
**Wood Dale, IL 60191**  
**or**  
**Fax: 888-331-5764**

## DEFECTS WARRANTY REQUIREMENTS:

- (a) The warranty period begins on the date the engine or equipment is delivered to an ultimate purchaser.
- (b) **General Emissions Warranty Coverage.** Power Solutions International, Inc. must warrant each LSI engine to the ultimate purchaser and each subsequent owner that the engine is:
  - (1) Designed, built, and equipped so as to conform with all applicable regulations adopted by the Air Resources Board and the US EPA; and
  - (2) Free from defects in materials and workmanship that causes the failure of a warranted part for a period of two years.
- (c) The warranty on emissions-related parts will be interpreted as follows:
  - (1) Any warranted part that is not scheduled for replacement as required maintenance in the written instructions required by subsection (d) must be warranted for the warranty period defined in Subsection (b)(2). If any such part fails during the period of warranty coverage, it must be repaired or replaced by the manufacturer according to Subsection (4) below. Any such part repaired or replaced under the warranty must be warranted for the remaining warranty period.
  - (2) Any warranted part that is scheduled only for regular inspection in the written instructions required by subsection (d) must be warranted for the warranty period defined in Subsection (b)(2). A statement in such written instructions to the effect of “repair or replace as necessary” will not reduce the period of warranty coverage. Any such part repaired or replaced under warranty must be warranted for the remaining warranty period.
  - (3) Any warranted part that is scheduled for replacement as required maintenance in the written instructions required by subsection (d) must be warranted for the period of time prior to the first scheduled replacement point for that part. If the part fails prior to the first scheduled replacement, the part must be repaired or replaced by the engine manufacturer according to Subsection (4) below. Any such part repaired or replaced under warranty must be warranted for the remainder of the period prior to the first scheduled replacement point for the part.
  - (4) Repair or replacement of any warranted part under the warranty must be performed at no charge to the owner at a warranty station.
  - (5) Notwithstanding the provisions of Subsection (4) above, warranty services or repairs must be provided at all manufacturer distribution centers that are franchised to service the subject engines.
  - (6) The owner must not be charged for diagnostic labor that leads to the determination that a warranted part is in fact defective, provided that such diagnostic work is performed at a warranty station.
  - (7) The manufacturer is liable for damages to other engine components proximately caused by a failure under warranty of any warranted part.
  - (8) Throughout the emissions warranty period defined in Subsection (b)(2), the manufacturer must maintain a supply of warranted parts sufficient to meet the expected demand for such parts.
  - (9) Any replacement part may be used in the performance of any warranty maintenance or repairs and must be provided without charge to the owner. Such use will not reduce the warranty obligations of the manufacturer.
  - (10) Add-on or modified parts that are not exempted by the Air Resources Board and US EPA and may not be used. The use of any non-exempted add-on or modified parts will be grounds for disallowing a warranty claim. The manufacturer will not be liable to warrant failures of warranted parts caused by the use of a non-exempted add-on or modified part.

- 
- (11) The manufacturer issuing the warranty shall provide any documents that describe that manufacturer's warranty procedures or policies within five working days of request by the Air Resources Board.

**(d) Emission Warranty Parts List**

- (1) Fuel Metering System
- (A) Fuel injection system
  - (B) Air/fuel ratio feedback and control system
  - (C) Carburetor system (internal parts and/or pressure regulator or fuel mixer or injection system)
  - (D) Cold start enrichment system
- (2) Air Induction System
- (A) Intake manifold(s) or air intake system
  - (B) Air mass sensor assembly
  - (C) Turbocharger/supercharger systems
- (3) Ignition Control System
- (A) Engine Control Module (ECM).
  - (B) Ignition module(s)
- (4) Positive Crankcase Ventilation (PCV) System.
- (A) PCV Valve
  - (B) Oil Filler Cap
- (5) Catalyst System
- (A) Catalytic converter\*
  - (B) Exhaust manifold
- (6) Evaporative Emissions Components
- (A) Fuel Tank\*\*
  - (B) Fuel Cap\*\*
  - (C) Fuel Line\*\*
  - (D) Fuel Line Fittings\*\*
  - (E) Control Solenoids\*\*
- (7) Miscellaneous items Used in Above Systems
- (A) Vacuum, temperature, and time sensitive valves and switches
  - (B) Sensors used for electronic controls
  - (C) Hoses, belts, connectors, assemblies, clamps, fittings, tubing, sealing gaskets or devices, and mounting hardware
  - (D) Pulleys, belts and idlers

\* Indicates high cost warranty item

\*\* As related to the evaporative emission control system. Components may be alternatively covered under the equipment warranty.



# Operating Instructions

## Fuel Systems

The fuel system installed on your engine operates with an Electronic Pressure Regulator (EPR) and a diaphragm style variable venturi mixer. The EPR will regulate the fuel pressure being delivered to the mixer; these parts are not adjustable and should not be tampered with. Proper inlet fuel pressure is critical to the proper operation of the fuel system and engine; you should review the pressure, volume, and BTU recommendations prior to commissioning the engine.

## Governors

PSI engines have an isochronous governor installed. The governor controls the movement of the throttle plate via a 0-12 volt signal and a ground provided by the Engine Control Module. The throttle plate allows the correct amount of air to enter the engine; this movement is monitored by using 2 throttle position sensors located internal to the governor. The ECM monitors various engine sensors to determine what the correct throttle position should be.

## Oil Pressure Reading

The oil pressure reading shows the engine lubrication system pressure in pounds per square inch (psi) and should be checked frequently to ensure that the system is functioning correctly. Should the pressure fluctuate or drop, stop the engine and find the cause. Do not operate the engine at lower than normal oil pressure (see maintenance schedule for minimum engine oil pressure).

**CAUTION:** Do not continue to operate your engine below the normal operating range. Severe engine damage could occur.

## Temperature Reading

The coolant temperature reading will indicate overheating which may arise from low coolant level, plugged radiator, loose fan belt or faulty thermostat. Coolant level should be checked daily.

**CAUTION:** If the engine continues to overheat, have the cooling system checked and serviced.

## Voltage Reading

The voltage reading indicates the battery charging voltage. If the meter consistently indicates less than 13 volts or more than 15.7 volts under normal operating conditions, you should have the engine electrical system checked by a qualified service technician.

## Starting the Engine

**Warning:** All internal combustion engines give off various fumes and gases while running. Do not start or run the engine in a closed or poorly ventilated building where exhaust gases can accumulate. Avoid breathing these gases as they may contain poisonous carbon monoxide, which can endanger your health or life if inhaled steadily for even a few minutes.

If the engine is equipped with a manual clutch it must be disengaged prior to starting the engine. Starting the engine with the clutch engaged imposes unnecessary strain on the battery, starter, and driven components.

**CAUTION:** If the engine stalls or falters during starting, wait 3 to 4 seconds before re-engaging the starter. This will prevent possible damage to the starter or the engine. DO NOT operate the starter for periods longer than 30 seconds at a time. An interval of at least 1-minute should be observed between cranking periods to protect the starter from overheating.

## Stopping the Engine

Return the engine to idle speed. If the machine is equipped with a clutch, move the clutch lever to the disengaged position. Run engine for a few minutes at idle to allow the coolant system to cool down before turning the ignition switch to the OFF position.

**Note:** Gasoline fuel injected engines will generally shut off immediately when the key is switched to the off position. When the key is switched off, power to the fuel injector(s), fuel pump and engine control module (ECM) is removed.

**Note:** LPG engines equipped with a distributor less ignition system (DIS) may run on several seconds after the key is switched to the off position. This may be a normal function of the engine control system running fuel out of the vapor hose to prevent engine backfiring on restart. The engine may run up to 5 seconds after the key is switched to off. Check with the Equipment Manufacture for proper shut down operation.

**WARNING:** Avoid injury when checking a Hot Engine. Allow the engine to cool down before removing the radiator cap.

**CAUTION:** Before restarting the engine ensure that both the coolant system and the engine oil level have been checked and re-filled if necessary.

# Fuel Recommendations

## LPG, NG and Gasoline Fuel Systems

Turn on the gas supply to the engine. Turn the ignition key to the START position. After the engine starts release the key to the ON position.

### NG Quality

For more information on fuel quality please consult PSI Technical Standard 36300017-PSI Fuel Standard. LPG engines and fuel systems are designed to operate on HD-5 or HD-10 specification LPG fuel. Fuel other than HD-5 or HD-10 may cause harm to the engine's emission control system and a warranty claim may be denied on this basis if operators can readily find the proper fuel. Use of any other fuel may result in your engine no longer operating in compliance with CARB or EPA emissions requirements.

### LPG Fuel Quality

LPG engines and fuel systems are designed to operate on HD-5 or HD-10 specification LPG fuel. Fuel other than HD-5 or HD-10 may cause harm to the engine's emission control system and a warranty claim may be denied on this basis if operators can readily find the proper fuel.

### Gasoline

Using a high quality unleaded gasoline will help maintain the power, fuel economy and emissions performance of your engine. A properly formulated gasoline will be comprised of well refined hydrocarbons and chemical additives and will perform the following functions:

1. Minimize varnish, lacquer, and other induction system deposits.
2. Prevent gum formation or other deterioration during storage.
3. Protect fuel tank and other fuel system components from corrosion or degradation.
4. Provide the correct seasonally and geographically adjusted volatility which should provide easy starting in the winter and summer.
5. Avoid fuel system icing.

In addition, the fuel must be free of water, debris, and other impurities. It is recommended that the fuel supply be kept fresh when the engine is in storage (especially in hot weather).

The fuel tank should be kept at least  $\frac{3}{4}$  full. Fuel stored for more than two months should be drained, properly discarded, and the fuel tank re-filled.

### **Anti-Knock Index (Octane Rating)**

This engine is designed to operate on unleaded 87 or 89 octane gasoline with an  $(R + M)/2$  minimum anti-knock index. Federal regulations require that each retail gasoline dispensing pump must display a label bearing the minimum index rating.

Use of unleaded gasoline with anti-knock index rating lower than 87 can cause persistent, heavy spark knock, which can lead to engine damage. If your engine knocks heavily when you use gasoline with an anti-knock index rating of 87 or higher, or if you hear continuous spark knock while maintaining constant operating speeds, consult a dealer or qualified technician.

### **Gasohol and Alcohol/Gasoline Fuels**

Gasohol, a mixture of gasoline and ethanol (grain alcohol), is available in some areas. PSI, GM Powertrain engines should operate satisfactorily on gasohol blends containing no more than 10% ethanol by volume and having an anti-knock index of 87 or 89. CAUTION: In some cases, methanol (wood alcohol) or other alcohols may be added to gasoline. PSI GM Powertrain engines should operate satisfactorily on blends containing up to 5% methanol by volume when cosolvents and other necessary additives are used. DO NOT USE blends containing more than 5% methanol by volume or blends that do not contain cosolvents and corrosion inhibitors.

CAUTION: Discontinue use of any gasohol or alcohol/gasoline blend if fuel system problems occur. Do not use such fuels unless they are UNLEADED.

## **Power Loss at Higher Elevations**

All engines will experience power loss when operated at elevations above sea level, unless they are turbocharged or supercharged. Turbochargers and superchargers are mechanical pumps that put extra air into the engine to make up for the lower air density at higher elevations.

# **MAINTENANCE INSTRUCTIONS**

## **Initial Start Up Maintenance**

The initial start-up checks must be made before putting the engine into service. Please refer to the Maintenance Schedule and perform the initial start-up operations in the sequence shown in column 1.

## **Routine Maintenance**

Routine maintenance provides the best solution for making sure that the engine is ready when you are. The following are some routine service points:

- Make daily checks of the engine oil and coolant levels
- Repair any oil or coolant leaks immediately
- Check battery condition and cables frequently
- Keep the engine air filter clean
- Monitor engine coolant temperature
- Monitor engine oil pressure
- Check voltmeter and charging system

## **Scheduled Preventive Maintenance**

Refer to the Maintenance Schedule to ensure that all of the maintenance items listed are checked and replaced as recommended at the hours shown.

## **Engine Oil Level Check**

The engine oil level should be checked daily. It is recommended that the oil be checked just before the engine is started for the first time for that day. The oil level should be between the 'Add' and the 'Full' marks on the dipstick.

**CAUTION:** Do not operate the engine with the oil level below the bottom or 'Add' mark on the dipstick, or above the top or 'Full' mark on the dipstick.

## Adding Engine Oil

It is normal to add some oil in the period of time between oil changes. The amount will vary with the severity of operation. When adding or replacing engine oil, be sure the oil meets or exceeds the recommended specification.

## Changing Engine Oil and Filter

The engine oil and filter must be changed every 150 hours or every 3 months whichever occurs first. Under normal operating conditions, you do not need to change them more often if you use oil and filters of the recommended quality.

The oil and filter should be changed more often if the engine is operating in dusty or extremely dirty areas, or during cold weather. No oil additives or break-in oil change is required.

## Engine Oil Quality

To achieve proper engine performance and durability, it is important that you use only engine lubricating oils of the correct quality in your engine. Proper quality oils also provide maximum efficiency for crankcase ventilation systems, which reduces pollution.

Important: use only engine oils displaying the American Petroleum Institute (API) “Starburst” Certification Mark ‘FOR GASOLINE ENGINES’ on the container.



PSI recommends using engine oils that have an API rating of SM or newer. Gasoline engines that are converted for LPG or NG fuels **MUST** use oils labeled ‘FOR GASOLINE ENGINES’. Do not use oils that are specifically formulated for Diesel Engines only. CC or CD classifications oils, even when labeled Heavy Duty or for Natural Gas Engines, **ARE NOT ACCEPTABLE**.

## **Engine Oil Recommendation**

Multi-viscosity oils are recommended. SAE 10W-30 is recommended for your engine from 0 degrees F (-18 degrees C) or above. If ambient temperatures are consistently below 0 degrees F, SAE 5W-30 oil can be used. Synthetic oils are not required for industrial or stationary engines.

## **Oil Filter**

The filter protects your engine from harmful, abrasive, or sludgy particles without blocking the flow of oil to vital engine parts.

To replace the filter, use a proper filter wrench to remove the filter.

Clean the filter mounting base and lightly coat the gasket surface of the new filter with engine oil. Hand tighten the filter until the gasket contacts the base, then tighten another ½ turn. Fill the engine with the correct amount of oil and run the engine. Verify oil pressure is okay and check for oil leaks at the drain plug and oil filter gasket. Tighten as necessary to stop any oil leakage noted.

## **Engine Air Cleaner**

The engine air cleaner filters air entering the engine intake system and acts as a silencer and flame arrester when assembled to the intake system. Air that contains dirt and grit produces an abrasive fuel mixture and can cause severe damage to the cylinder walls and piston rings. Damage to the cylinder walls and piston rings will cause high oil consumption and shorten engine life. A restricted or dirty air cleaner will also cause a rich fuel mixture. Thus, it is extremely important that the air cleaner be serviced properly at the recommended intervals.

**CAUTION:** Service the air cleaner more frequently under severe dusty or dirty conditions.

Remove the primary air cleaner element from the air cleaner assembly and inspect the element for foreign material restrictions or signs of excessive wear or damage. Replace the element if necessary. Remove all dust and foreign matter from the air cleaner housing. Reinstall the air cleaner element. Reinstall the air cleaner cup, and securely fasten the retaining clips.

## **Safety Element**

If your engine is equipped with an air cleaner which utilizes a safety element, ensure that the element is properly in place before installing the primary element.

Change the safety element annually.

## Cooling System

### Coolant Level

Check the coolant level of the radiator daily and only when the engine is cool. Generally a good time to do this is just prior to starting the engine for the first time each day.

Maintain the coolant level at  $\frac{3}{4}$  to  $1\frac{1}{2}$  inches below the filler neck seat of the radiator when the coolant is cold. When ever coolant level checks are made inspect the condition of the radiator cap rubber seal. Make sure it is clean and free of any dirt particles which would keep it from seating on the filler neck seat. Rinse off with clean water if necessary. Also make sure that the filler neck seat is free of any dirt particles.

**WARNING:** Never remove the radiator cap under any conditions while the engine is operating. Failure to follow these instructions could result in damage to the cooling system, engine, or cause personal injury. To avoid having scalding hot coolant or steam blow out of the radiator, use extreme caution when removing the radiator cap from a hot radiator. If possible, wait until the engine has cooled, then wrap a thick cloth around the radiator cap and turn slowly to the first stop. Step back while the pressure is released from the cooling system. When all the pressure has been released, press down on the cap and remove it slowly.

DO NOT add coolant to any engine that has become overheated until the engine cools. Adding coolant to an extremely hot engine can result in a cracked block or cylinder head.

The engine manufacturer recommends the cooling system be filled with a 50/50 mixture of coolant and water. The use of "Long Life" type coolant is required. This coolant is typically a bright orange in color and **should meet the requirements outlined in engineering standard GM6277M** (hard copy of GM6277M is available by contacting PSI Technical Support). Coolant should have a minimum boiling point of 300F (149c) and a freezing point no higher than -34F (-37c).

Plain water may be used in an emergency (except in freezing temperatures), but replace it with the specified coolant as quickly as possible to avoid damage to the system.

### Radiator

Inspect the exterior of the radiator for obstructions. Remove all bugs, dirt or foreign material with a soft brush or cloth. Use care to avoid damaging the core fins. If available, use low pressure compressed air or a stream of water in the opposite direction of the normal air flow. Check all hoses and connections for leaks. If any of the hoses are cracked, frayed, or feel spongy, they must be replaced.



## Fan Belts

The water pump is belt driven. The same belt may also drive the fan and/or the alternator. The drive belts should be properly adjusted at all times. A loose belt can cause improper alternator, fan and water pump operation, in addition to overheating.

## Serpentine Belt

Some PSI engines utilize serpentine belts on the front of the engine. This type of belt system incorporates a belt tensioning device which keeps the belt at the proper tension.

This belt should be checked routinely for cracks or 'checking' on the groove side of the belt. If cracks or 'checking' are apparent the belt must be changed.

## V-Type Belt

V-Type belts are generally tensioned by adjusting the alternator, or through a mechanical belt tensioner. The belt is generally correctly tensioned when there is 7-10mm of deflection on the belt between the water pump and alternator.

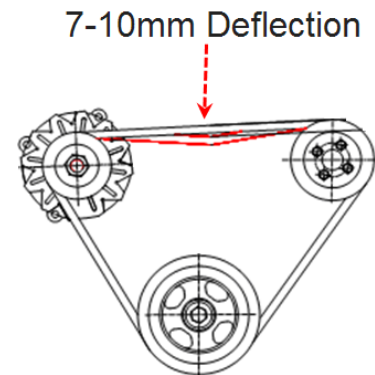

## Fuel Filter

### LPG Engines

LP, fuel like all other motor fuels is subject to contamination from outside sources. Refueling of the equipment tank and removal of the tank from the equipment can inadvertently introduce dirt and other foreign matter into the fuel system. It is therefore necessary to filter the fuel prior to entering the fuel system components down stream of the tank. An inline fuel filter has been installed in the fuel system to remove the dirt and foreign matter from the fuel, which is replaceable as a unit only. Maintenance of the filter is critical to proper operation of the fuel system and should be replaced according to the maintenance schedule or more frequently under severe operating conditions.

## Fuel Shut-Off

LPG and NG engines are equipped with a fuel shut-off. The fuel shut-off is located between the fuel supply and the IEPR/DEPR. The purpose of the fuel shut off is to prevent or allow fuel flow from the supply source to the engine fuel system. The shut off is a 12 volt solenoid (Normally closed) that is controlled by the engine ECM.

# Ignition Systems

## Types of Ignition Systems

PSI engines use two types of ignition systems:

- 1) **Distributor-less electronic ignition**, which consist of Coil-On-Plug (COP) **OR** Coil-Near-Plug (CNP).
- 2) **High Voltage Switch (HVS) ignition**, which consist of a distributor and HVS ignition coil.

## Ignition Timing

Ignition timing for both the Distributor-less and HVS systems are controlled by the ECU and is not adjustable. Engines using HVS Distributor ignition systems require the distributor alignment to be set +/- 7 CAD using the electronic service tool while engine is running.

**NOTE: Do not attempt to adjust timing on the ignition systems. Timing is not adjustable.**

## Spark Plugs

Spark plugs should be replaced at the recommended intervals described in the Maintenance Schedule. Use only the recommended spark plug or an equivalent as described in the General Specifications.

Spark plug gap should be adjusted as recommended in the General Specifications.

When removing spark plugs, always note which cylinder each plug came out of. Look at the porcelain around the center electrode of each plug. You can detect many engine problems from the color and type of deposits that have built up on the white porcelain. For example, if the deposits are a glossy brown, that cylinder is burning excess oil. If the deposits are a very dark gray or sooty black color, your engine is running rich, and you are burning excess fuel. The optimum color of the deposits on the porcelain is light tan or light brown. This shows optimum fuel mixture and proper engine running conditions. If the deposits are almost white, the engine may be running excessively lean.

Lean running is very detrimental to your engine life, and should be corrected immediately. If one or more cylinders are burning oil, the smoke from the engine will be a blue-gray color. Most common causes are piston rings (worn out or not broken in) and valve stem seals (cut, nicked, or worn out). If the engine is running rich the exhaust smoke will be a sooty black color and it will smell like gasoline (on gasoline engines).

## Storage

### One to Six Months

If the engine or machine is to be placed in storage for a period of one to six months it is recommended that the following steps be followed:

- Protect the air cleaner inlet from water entry
- Protect the exhaust outlet or muffler outlet from water entry
- Check the coolant protection and top off radiator
- Store indoors if possible

### For Extended Periods

Follow the above recommended procedures, plus do the following:

- Drain the engine crankcase and refill with recommended oil
- Change the oil filter
- Disconnect and remove the battery
- Clean exterior surface of the engine
- If the engine is equipped with an automotive type clutch or PTO clutch, make sure that the clutch is disengaged

### Removing the Engine From Extended Storage

When removing the engine from extended storage:

- Install a fully charged battery
- Remove all protective coverings from the air inlet, air cleaner, exhaust, and muffler openings
- Check the coolant level in the radiator and verify the protection level of the coolant
- Check the engine oil level.
- Start the engine and allow it to run at slow idle. Verify engine oil pressure
- Run the engine at idle until the coolant temperature approaches 120 degrees F (49 degrees C)
- Run the engine a various speeds for approximately 15 minutes
- Shut the engine down, drain the oil, change the oil filter, and re-fill with the recommended grade of oil

# Engine Maintenance Requirements

<b>CERTIFIED STATIONARY ENGINE MAINTENANCE REQUIREMENTS</b>										
Perform the following maintenance on the engine at the hours indicated and at equivalent hour intervals thereafter.										
	Interval Hours									
	Daily	1000	1500	2000	2500	3000	3500	4000	4500	5000
<b>General Maintenance Section</b>										
Visual check for fluid leaks	X									
Check engine oil level	X									
Check coolant level	X									
Change engine oil and filter	<b>Every 150 hours or 120 days of operation</b>									
Check LPG system for leaks	Prior to any service or maintenance activity									
Inspect accessory drive belts for cracks, breaks, splits or glazing		X		X		X		X		X
Inspect electrical system wiring for cuts, abrasions or corrosion				X				X		
Replace crankcase breather element - 8.1L/8.8L Engine	<b>Every 150 hours or 120 days of operation</b>									
Inspect all vacuum lines and fittings for cracks, breaks or hardening				X				X		
<b>Engine Coolant Section</b>										
Clean debris from radiator core	<b>Every 100 hours or 60 days of operation</b>									
Change coolant <sup>1</sup>										X
Inspect coolant hoses for cracks, swelling or deterioration		X		X		X		X		X
<b>Engine Ignition System</b>										
Replace spark plugs		X	X			X				
Clean secondary ignition coil tower		X		X		X		X		X
Check spark plug wires for cuts abrasions or hardening		X								
Replace distributor cap and rotor				X				X		
Replace spark plug wires				X				X		
<b>Fuel System Maintenance</b>										
Inspect air cleaner	<b>Every 200 hours, or every 100 hours in dusty environment</b>									
Replace filter element	Annually, or as required in dusty environments									
Replace fuel filter		X		X		X		X		X
Inspect Shut-off Valve for leaks and closing				X				X		
Leak check fuel lines				X				X		
Check air induction for leaks		X		X		X		X		X
Check manifold for vacuum leaks		X		X		X		X		X
Drain Vaporizer oil build up	<b>Every 2500 hrs or As Required</b>									
<b>Engine Exhaust System</b>										
Inspect exhaust manifold for leaks				X				X		
Inspect exhaust piping for leaks				X				X		
Check HEGO sensor(s) connector and wires for burns, cuts or damage				X				X		
Inspect catalyst for mechanical damage				X				X		
<b>SPECIAL NOTES SECTION</b>										
<p>Note 1 = PSI requires the use of coolant meeting GM specification GM6277M. When used, this coolant change interval is 5,000 hours or 5 years (whichever occurs first). Changing of coolant types (typically indicated by color) and mixing of coolants is not allowed as this can result in a loss of coolant protection during the engine life. Consult the OEM for the correct replacement interval if you use coolant other than GM6277M</p>										

# GENERAL SPECIFICATIONS

## Power Solutions, Inc.

Engine	2.4L	3.0L	4.3L	PSI 4.3L (4X)	5.0L/5.7L Turbo	8.8L/8.8L Turbo
Type	2.4L L4	3.0L L4	4.3L V-6	4.3L V-6	5.7L V-8 GEN-1E	8.8L V-8
Displacement cc (c.i.d.)	2351 (143)	2966 (181)	4294 (262)	4294 (262)	5735 (350)	8800 (537)
Compression Ratio	9.5:1	10.5:1	9.4:1	9.8:1	9.4:1	10:1
Valve Configuration	4V SOHC	Push Rod Actuated Overhead Valve	Push Rod Actuated Overhead Valve	Push Rod Actuated Overhead Valve	Push Rod Actuated Overhead Valve	Push Rod Actuated Overhead Valve
Valve Lifters	Hydraulic	Flat Follower	Hydraulic Roller	Hydraulic Roller	Hydraulic Roller	Hydraulic Roller
Bore x Stroke mm (inches)	86.5x100 (3.41x3.94)	101.60x91.44 (4.00x3.60)	101.60x88.39 (4.00x3.48)	101.60x88.39 (4.00x3.48)	101.60x88.39 (4.00x3.48)	110.49x114.30 (4.35x4.50)
Main Bearing Caps	2 Bolt	2 Bolt	2 Bolt	2 Bolts	2 Bolt	4 Bolt
Firing Order	1-3-4-2	1-3-4-2	1-6-5-4-3-2	1-6-5-4-3-2	1-8-4-3-6-5-7-2	1-8-7-2-6-5-4-3
Oil Capacity	4.75 qts. (4.5L)	4 qts. (3.8L)	4.5 qts. (4.3L)	4.5 qts (4.3L)	4.5 qts. (4.3L)	8 qts. (7.6L)
With Oil Filter	5 qts (4.7L)	5 qts. (4.7L)	5 qts. (4.7L)	5 qts (4.7L)	5 qts. (4.7L)	9 qts (8.5L)
Oil Filter	PSI 801002	PF-25 or Equivalent	PF-47/PF-52 or Equivalent	PF-47/PF-52 or Equivalent	PF-1218 or Equivalent	30100345 or Equivalent
Minimum Oil Pressure (Hot)	10 psi @ 800 rpm	6 psi @ 1000 rpm	6 psi @1000 rpm	6 psi @1000 rpm	6 psi @ 1000 rpm	5 psi @ 1000 rpm
		18 psi @ 2000 rpm	18 psi @ 2000 rpm	18 psi @ 2000 rpm	18 psi @ 2000 rpm	15 psi @ 2000 rpm
Coolant Capacity (Engine)	Confirm with Equipment OEM	4 qts. (3.78L)	7.75 qts. (7.3L)	7.75 qts. (7.3L)	8.1 qts (7.8L)	14.2 qts (13.4 L)
Coolant Capacity (W/PSI Rad)	N/A	12 qts. (11.4L)	17 qts. (16L)	17 qts. (16L)	17.5 qts. (16.6L)	26.9 qts (25.5L)
Fuel Type	LPG, NG, Gasoline	LPG, NG	LPG, NG	LPG, NG, Gasoline	LPG, NG	LPG, NG, Gasoline
Engine Rotation (Flywheel End)	CCW	CCW	CCW	CCW	CCW	CCW
Ignition System	Coil on Plug	High Voltage Switch (HVS)	High Voltage Switch (HVS)	Coil Near Plug (CNP)	High Voltage Switch (HVS)	Coil Near Plug (CNP)
Ignition Timing	ECM Controlled	ECM Controlled	ECM Controlled	ECM Controlled	ECM Controlled	ECM Controlled
	Not Adjustable	Not Adjustable	Not Adjustable	Not Adjustable	Not Adjustable	Not Adjustable
Spark Plugs	Torch, PSI # 800300 (14 MM) or PSI # 801001 (12 MM)	AC Delco R42LTS or R44LTS	AC Delco R42LTS or R44LTS	AC Delco R42LTS or R44LTS	33000562 or Equivalent	33000562 or Equivalent
Spark Plug Gap	14 mm Plug - 0.040"	0.035"	0.035"	0.035"	0.035"(5.0/5.7L None Turbo)	0.030" (Non-Turbo)
	12 mm Plug - 0.035"				0.023"(5.0/5.7L Turbo)	.025" (Turbo)
Valve Clearance (Lash)						
Intake	No Adjustment	½ to 1 Turn Down From	Net Lash	Net Lash	1 Turn Down From	Net Lash
Exhaust	OHC Engine	0 Lash	No Adjustment	No Adjustment	0 Lash	No Adjustment
Manufactured	Shenyang, China	Toluca, Mexico	Romulus, MI	Wood Dale, IL	Toluca, Mexico	Wood Dale, IL

Not for reproduction

Not for reproduction



**POWER SOLUTIONS  
INTERNATIONAL**

---

Power Solutions International, Inc (PSI)  
201 Mittel Drive  
Wood Dale, IL 60191  
USA  
630-350-9400

Not for reproduction

